

COMPONENT SCHEDULE

SINGLE WIDTH SPAN TOWERS WITH LADDER FRAMES TO BSEN 1004-2004 5 RUNG STARTER FRAMES

Using the 3T (Through the Trap) Assembly method

INTERNAL & EXTERNAL USE

PLATFORM HEIGHT	METRIC IMPERIAL	2.4 7'10"	2.9 9'6"	3.4 11'2"	3.9 12'10"	4.4 14'5"	4.9 16'0"	5.4 17'9"	5.9 19'4"	6.4 21'0"	6.9 22'8"	7.4 24'3"	7.9 25'11"
DESCRIPTION	CODE												
1.8 m x 0.8 m SPAN													
150mm Adjustable Castor	2230	4	4	4	4	4	4	4	4	4	4	4	4
1.8m SingleToeboard	2065	1	1	1	1	1	1	1	1	1	1	1	1
0.8m 5 Rung Base Frame	2015	1	1	1	1	1	1	1	1	1	1	1	1
0.8m 5 Rung Ladder Frame	2222	1	1	1	1	1	1	1	1	1	1	1	1
0.8m 4 Rung Main Frame	2016	-	-	1	-	1	1	2	1	2	2	3	2
0.8m 4 Rung Ladder Frame	2223	-	-	1	-	1	1	2	1	2	2	3	2
0.8m 3 Rung Frame	2018	-	1	-	1	-	1	-	1	-	1	-	1
0.8m 3 Rung Ladder Frame	2224	-	1	-	1	-	1	-	1	-	1	-	1
0.8m 2 Rung Frame	} * { 2019	1	-	-	1	1	-	-	1	1	-	-	1
0.8m 2 Rung Ladder Frame		2225	1	-	-	1	1	-	-	1	1	-	-
1.8m Brace*	2040	6	10	10	10	10	14	14	14	14	18	18	18
2.7m Brace	2041	3	2	3	2	4	3	4	3	5	4	5	4
1.8m 3 Rung Blue Brace	2080	-	1	-	2	-	1	-	2	-	1	-	2
1.8m Ladder Span Trap Platform	2201	1	2	2	2	2	3	3	3	3	4	4	4
Small Stabiliser (up to 7.4m)	2056	4	4	4	4	4	4	4	4	4	4	4	-
Large Stabiliser (7.9 - 10.4m)	2057	-	-	-	-	-	-	-	-	-	-	-	4
TOTAL SELF WEIGHT OF TOWER (KGS)		126	159	164	169	174	207	212	219	224	255	260	273
MAX. No. OF WORKING PLATFORMS		1	1	1	2	2	2	2	3	3	3	3	3

INTERNAL USE ONLY

8.4 27'7"	8.9 29'2"	9.4 30'10"	9.9 32'6"	10.4 34'9"
4	4	4	4	4
1	1	1	1	1
1	1	1	1	1
1	1	1	1	1
3	3	4	3	4
3	3	4	3	4
-	1	-	1	-
-	1	-	1	-
1	-	-	1	1
1	-	-	1	1
18	22	22	22	22
6	5	6	5	7
-	1	-	2	-
4	5	5	5	5
-	-	-	-	-
4	4	4	4	4
283	317	322	328	334
4	4	4	4	5

2.7 m x 0.8 m SPAN	CODE												
150mm Adjustable Castor	2230	4	4	4	4	4	4	4	4	4	4	4	4
2.7m SingleToeboard	2067	1	1	1	1	1	1	1	1	1	1	1	1
0.8m 5 Rung Base Frame	2015	1	1	1	1	1	1	1	1	1	1	1	1
0.8m 5 Rung Ladder Frame	2222	1	1	1	1	1	1	1	1	1	1	1	1
0.8m 4 Rung Main Frame	2016	-	-	1	-	1	1	2	1	2	2	3	2
0.8m 4 Rung Ladder Frame	2223	-	-	1	-	1	1	2	1	2	2	3	2
0.8m 3 Rung Frame	2018	-	1	-	1	-	1	-	1	-	1	-	1
0.8m 3 Rung Ladder Frame	2224	-	1	-	1	-	1	-	1	-	1	-	1
0.8m 2 Rung Frame	} * { 2019	1	-	-	1	1	-	-	1	1	-	-	1
0.8m 2 Rung Ladder Frame		2225	1	-	-	1	1	-	-	1	1	-	-
2.7m Brace	2041	6	10	10	10	10	14	14	14	14	19	19	19
3.3m Brace	2042	3	2	3	2	4	3	4	3	5	4	5	4
2.7m 3 Rung Black Brace	2083	-	1	-	2	-	1	-	2	-	1	-	2
2.7m Ladder Span Trap Platform	2202	1	2	2	2	2	3	3	3	3	4	4	4
Small Stabiliser (up to 7.4m)	2056	4	4	4	4	4	4	4	4	4	4	4	-
Large Stabiliser (7.9 - 10.4m)	2057	-	-	-	-	-	-	-	-	-	-	-	4
TOTAL SELF WEIGHT OF TOWER (KGS)		142	181	187	193	198	237	242	249	253	293	300	314
MAX. No. OF WORKING PLATFORMS		1	1	1	2	2	2	2	3	3	3	3	3

4	4	4	4	4
1	1	1	1	1
1	1	1	1	1
1	1	1	1	1
3	3	4	3	4
3	3	4	3	4
-	1	-	1	-
-	1	-	1	-
1	-	-	1	1
1	-	-	1	1
19	22	22	22	22
6	5	6	5	7
-	1	-	2	-
4	5	5	5	5
-	-	-	-	-
4	4	4	4	4
319	368	373	380	385
4	4	4	4	5

* or 2 Guardrail frames Code: 2017 (but see illustration 14, page 3, before use)

THE ABOVE SCHEDULE INCLUDES FOR:

- (i) 1 WORKING LEVEL WITH LADDERSPAN TRAP PLATFORM, TOEBOARDS AND DOUBLE HANDRAILS AT 0.5m AND 1m
- (ii) A LADDERSPAN TRAP PLATFORM & HANDRAILS. AS A REST PLATFORM EVERY 2m.

TO CONVERT A REST PLATFORM TO A WORKING PLATFORM ADD A SINGLE TOEBOARD

MAXIMUM WORKING LOAD ON A 0.61m WIDE x 1.8m LONG PLATFORM IS 2kN/m² WHICH IS 212kgs.

MAXIMUM WORKING LOAD ON A 0.61m WIDE x 2.7m LONG PLATFORM IS 2kN/m² WHICH IS 324kgs.

MAXIMUM LOAD ON THE TOWER (INCLUDING THE SELF WEIGHT OF THE TOWER) SHOULD NOT EXCEED 2500kgs

ON TOWERS NOT USING 2 RUNG FRAMES.

ON TOWERS USING 2 RUNG FRAMES, MAXIMUM LOAD ON TOWER IS 1500kg (1.5 TONNE) UNLESS ADDITIONAL SHORT BRACES HAVE BEEN ADDED (REFER TO SUPPLIER FOR MORE INFORMATION)

MAXIMUM HORIZONTAL FORCE WHEN USING HAND TOOLS ETC. SHOULD NOT EXCEED 30kgs.

STABILISERS MUST BE FITTED.

COMPONENT SCHEDULE

SINGLE WIDTH SPAN TOWERS WITH LADDER FRAMES TO BSEN 1004-2004 4 RUNG STARTER FRAMES

Using the 3T (Through the Trap) Assembly method

INTERNAL & EXTERNAL USE

PLATFORM HEIGHT	METRIC IMPERIAL	2.2 7'3"	2.7 8'10"	3.2 10'6"	3.7 12'2"	4.2 13'9"	4.7 15'5"	5.2 17'1"	5.7 18'8"	6.2 20'4"	6.7 22'0"	7.2 23'7"	7.7 25'3"
DESCRIPTION	CODE												
1.8 m x 0.8 m SPAN													
150mm Castor	2230	4	4	4	4	4	4	4	4	4	4	4	4
Adjustable Leg		4	4	4	4	4	4	4	4	4	4	4	4
1.8m SingleToeboard	2065	1	1	1	1	1	1	1	1	1	1	1	1
0.8m 4 Rung Main Frame	2016	1	1	2	1	2	2	3	2	3	3	4	3
0.8m 4 Rung Ladder Frame	2223	1	1	2	1	2	2	3	2	3	3	4	3
0.8m 3 Rung Frame	2018	-	1	-	1	-	1	-	1	-	1	-	1
0.8m 3 Rung Ladder Frame	2224	-	1	-	1	-	1	-	1	-	1	-	1
0.8m 2 Rung Frame	2019	1	-	-	1	1	-	-	1	1	-	-	1
0.8 2 Rung Ladder Frame	2225	1	-	-	1	1	-	-	1	1	-	-	1
1.8m Brace	2040	6	10	10	10	10	14	14	14	14	18	18	18
2.7m Brace	2041	-	-	1	-	2	1	2	1	3	2	3	2
1.8m 3 Rung Blue Brace	2080	3	3	2	4	2	3	2	4	2	3	2	4
1.8m Ladder Span Trap Platform	2201	1	2	2	2	2	3	3	3	3	4	4	4
Small Stabiliser (up to 7.4m)	2056	4	4	4	4	4	4	4	4	4	4	4	-
Large Stabiliser (7.9 - 10.4m)	2057	-	-	-	-	-	-	-	-	-	-	-	4
TOTAL SELF WEIGHT OF TOWER (KGS)		122	155	160	166	171	203	209	215	220	251	257	270
MAX. No. OF WORKING PLATFORMS		1	1	1	2	2	2	2	3	3	3	3	3

INTERNAL USE ONLY

8.2 26'11"	8.7 28'7"	9.2 30'2"	9.7 31'10"	10.2 33'6"
4	4	4	4	4
4	4	4	4	4
1	1	1	1	1
4	4	5	4	5
4	4	5	4	5
-	1	-	1	-
-	1	-	1	-
1	-	-	1	1
1	-	-	1	1
18	22	22	22	22
4	3	4	3	5
2	3	2	4	2
4	5	5	5	5
-	-	-	-	-
4	4	4	4	4
275	314	319	325	330
4	4	4	4	5

2.7 m x 0.8 m SPAN	CODE												
150mm Adjustable Castor	2230	4	4	4	4	4	4	4	4	4	4	4	4
2.7m SingleToeboard	2067	1	1	1	1	1	1	1	1	1	1	1	1
0.8m 4 Rung Main Frame	2016	1	1	2	1	2	2	3	2	3	3	4	3
0.8m 4 Rung Ladder Frame	2223	1	1	2	1	2	2	3	2	3	3	4	3
0.8m 3 Rung Frame	2018	-	1	-	1	-	1	-	1	-	1	-	1
0.8m 3 Rung Ladder Frame	2224	-	1	-	1	-	1	-	1	-	1	-	1
0.8m 2 Rung Frame	2019	1	-	-	1	1	-	-	1	1	-	-	1
0.8 2 Rung Ladder Frame	2225	1	-	-	1	1	-	-	1	1	-	-	1
2.7m Brace	2041	6	10	10	10	10	14	14	14	14	18	18	18
3.3m Brace	2042	-	-	1	-	2	1	2	1	3	2	3	2
2.7m 3 Rung Black Brace	2083	3	3	2	4	2	3	2	4	2	3	2	4
2.7m Ladder Span Trap Platform	2202	1	2	2	2	2	3	3	3	3	4	4	4
Small Stabiliser (up to 7.4m)	2056	4	4	4	4	4	4	4	4	4	4	4	-
Large Stabiliser (7.9 - 10.4m)	2057	-	-	-	-	-	-	-	-	-	-	-	4
TOTAL SELF WEIGHT OF TOWER (KGS)		139	181	186	193	198	240	245	251	257	292	304	317
MAX. No. OF WORKING PLATFORMS		1	1	1	2	2	2	2	3	3	3	3	3

4	4	4	4	4
1	1	1	1	1
4	4	5	4	5
4	4	5	4	5
-	1	-	1	-
-	1	-	1	-
1	-	-	1	1
1	-	-	1	1
18	22	22	22	22
4	3	4	3	5
2	3	2	4	2
4	5	5	5	5
-	-	-	-	-
4	4	4	4	4
322	375	380	387	393
4	4	4	4	5

* or 2 Guardrail frames Code: 2017 (but see illustration 14, page 3, before use)

THE ABOVE SCHEDULE INCLUDES FOR:

(i) 1 WORKING LEVEL WITH LADDERSPAN TRAP PLATFORM, TOEBOARDS AND DOUBLE HANDRAILS AT 0.5m AND 1m

(ii) A LADDERSPAN TRAP PLATFORM & HANDRAILS. AS A REST PLATFORM EVERY 2m.

TO CONVERT A REST PLATFORM TO A WORKING PLATFORM ADD A SINGLE TOEBOARD

MAXIMUM WORKING LOAD ON A 0.61m WIDE x 1.8m LONG PLATFORM IS 2kN/m² WHICH IS 212kgs.

MAXIMUM WORKING LOAD ON A 0.61m WIDE x 2.7m LONG PLATFORM IS 2kN/m² WHICH IS 324kgs.

MAXIMUM LOAD ON THE TOWER (INCLUDING THE SELF WEIGHT OF THE TOWER) SHOULD NOT EXCEED 2500kgs

ON TOWERS NOT USING 2 RUNG FRAMES.

ON TOWERS USING 2 RUNG FRAMES, MAXIMUM LOAD ON TOWER IS 1500kg (1.5 TONNE) UNLESS ADDITIONAL SHORT BRACES

HAVE BEEN ADDED (REFER TO SUPPLIER FOR MORE INFORMATION)

MAXIMUM HORIZONTAL FORCE WHEN USING HAND TOOLS ETC. SHOULD NOT EXCEED 30kgs.

STABILISERS MUST BE FITTED.

Industrial Aluminium Towers SINGLE WIDTH LADDERSPAN & VERTICAL LADDER ERECTION MANUAL

TO BS-EN 1004-2004

Using the 3T (Through the Trap) Assembly method

Using 2 rung frames (Recommended)

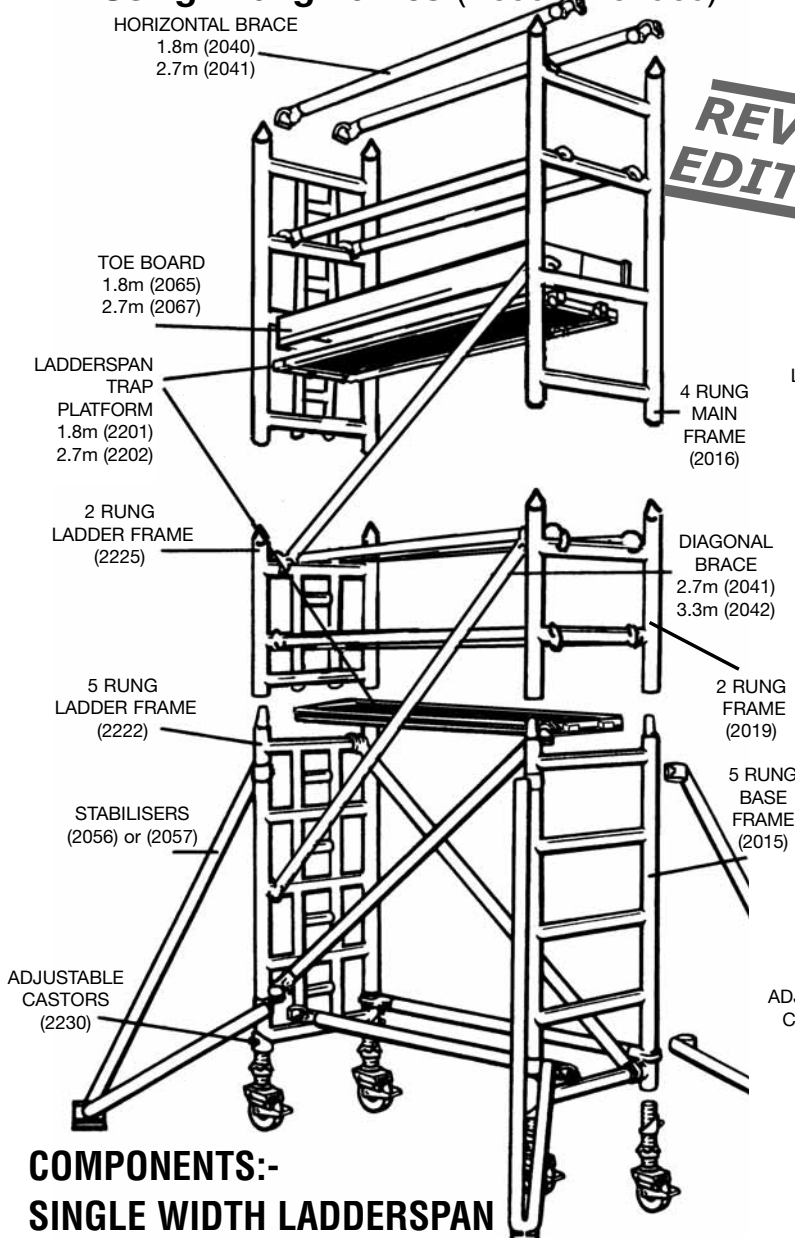

Using guardrail frames

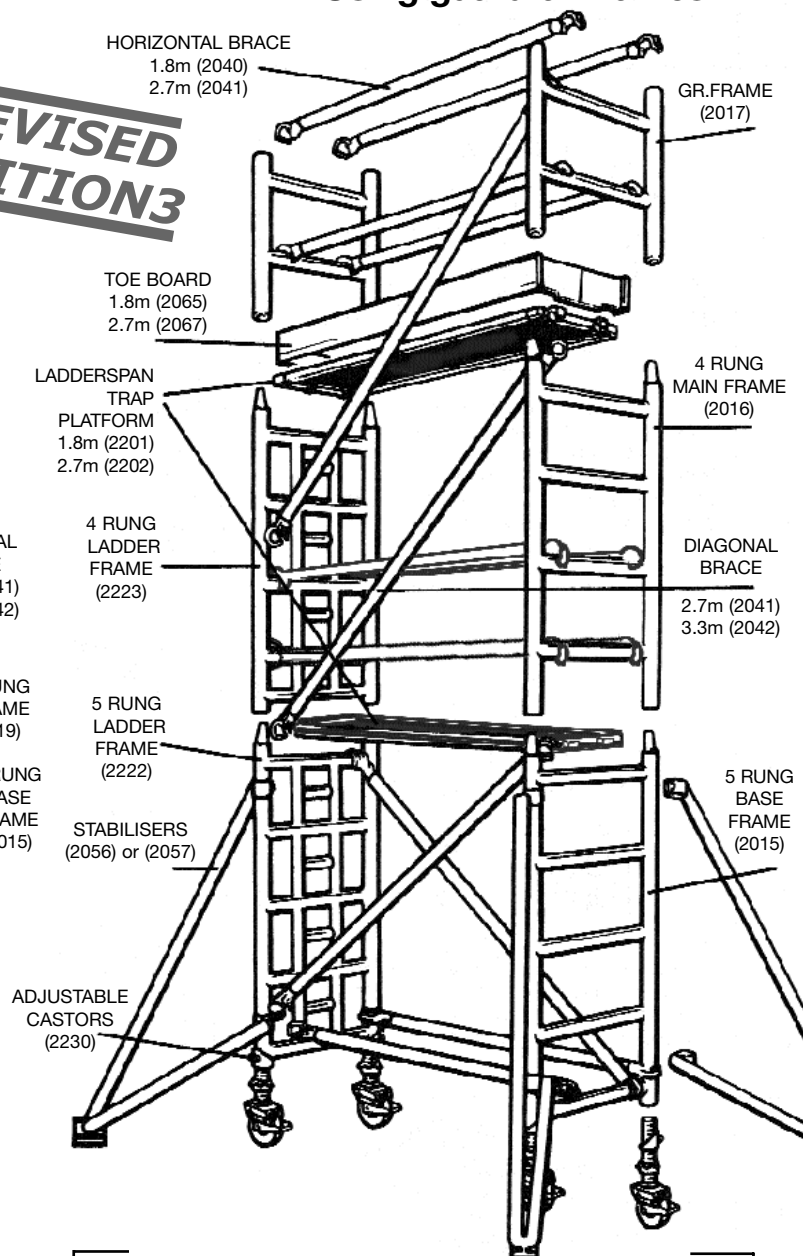

REVISED EDITION 3

Distributed by:-

**LADDER SPAN ERECTION MANUAL
WITH 5 RUNG STARTER FRAMES**

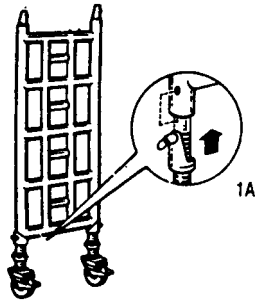

1. These towers should be erected by at least 2 competent persons. Contact your supplier for details of appropriate training. Check you have the correct equipment and it is in working order. Apply brakes and fit adjustable castors into both 5 rung frames ensuring that spring loaded pin is engaged in hole provided (see detail 1A).

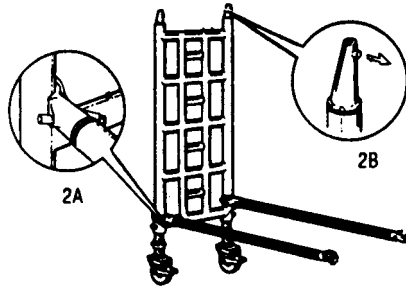

2. Make sure pegs on frame head fitting always point towards middle of tower (see detail 2B). Fit two short horizontal braces to vertical tubes of one of the frames ensuring spring loaded pin faces outwards (see detail 2A).

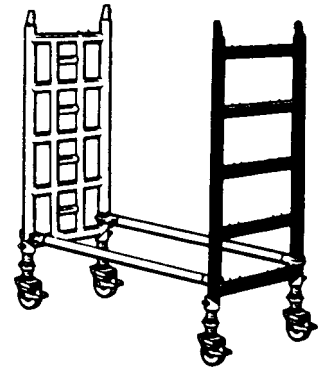

3. Fit opposite ends of short braces to other 5 rung base frame ensuring pegs on frame head fitting point towards middle of tower.

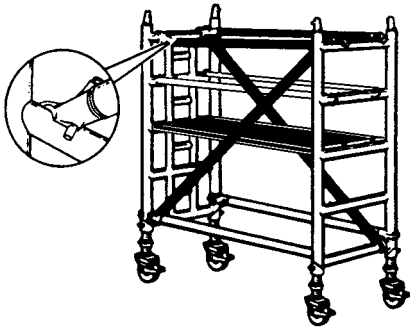

4. 1) Fit two long braces diagonally in opposite directions as close to the frame vertical tube as possible.
2) Fit a temporary platform on the third rung down from the top of the frame and, working through the trap fit short braces as temporary handrails onto frame uprights above top rungs of frames. At this stage level the tower by adjusting collar on castors (see notes).

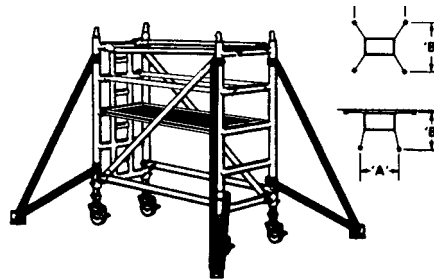

5. Fit appropriate stabilisers (see schedule on back page) to each corner of the tower to increase the effective base dimensions A & B. They must be fitted so that when viewed from above the largest square is formed. Ensure the wing nuts are tight so that it is not possible to move stabilisers without slackening the wing nuts.

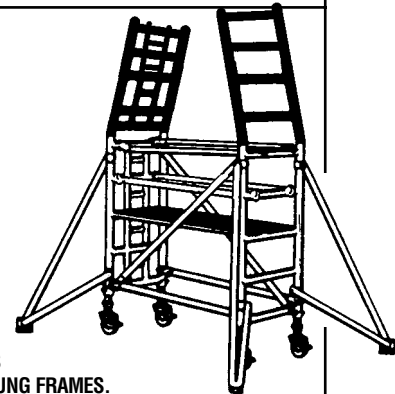

**6. FOR TOWERS
NOT USING 2 RUNG FRAMES.**

Working from a platform add a 4 rung ladder frame to the 5 rung ladder frame by locating onto head fitting with peg engaging into hole provided. Repeat the process at the other end using a 4 rung main frame.

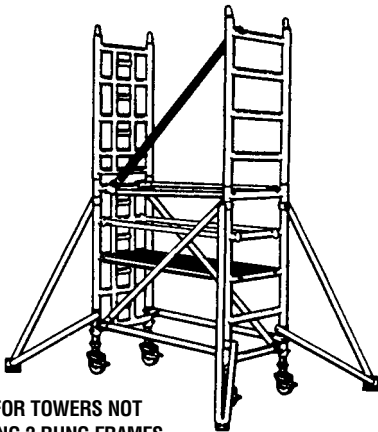

**7. FOR TOWERS NOT
USING 2 RUNG FRAMES.**
Fit one long diagonal brace as close to one of the frame vertical tubes as possible.

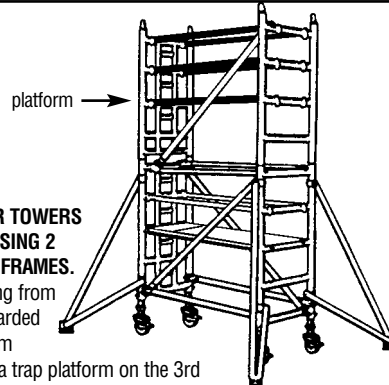

**8. FOR TOWERS
NOT USING 2
RUNG FRAMES.**
Working from the guarded platform locate a trap platform on the 3rd rung down from the top of the tower. Working through it's trap, fit short braces horizontally as guardrails. Continue building the tower repeating method from 6 until the required platform height is reached, then onto box 12, 13 or 14 (whichever is applicable)

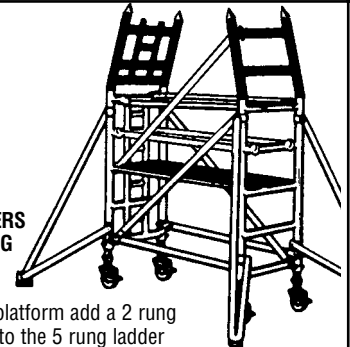

**9. FOR TOWERS
USING 2 RUNG
FRAMES.**

Working from a temporary platform add a 2 rung ladder frame to the 5 rung ladder frame by locating onto head fitting with peg, engaging into hole provided. Repeat the process at the other end using a 2 rung frame. Add a diagonal brace to the top rung of the 2 rung frame on one side of the tower. Fit short braces to form guardrails as before. Remove temporary platform and relocate onto 5th rung of base frame.

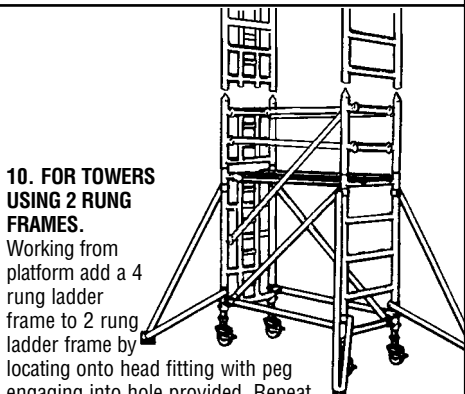

**10. FOR TOWERS
USING 2 RUNG
FRAMES.**
Working from platform add a 4 rung ladder frame to 2 rung ladder frame by locating onto head fitting with peg engaging into hole provided. Repeat the process at the other end using a 4 rung main frame. Working through the trap fit 4 short braces as guardrails fit two braces diagonally in opposite directions as close to the frame vertical tubes as possible.

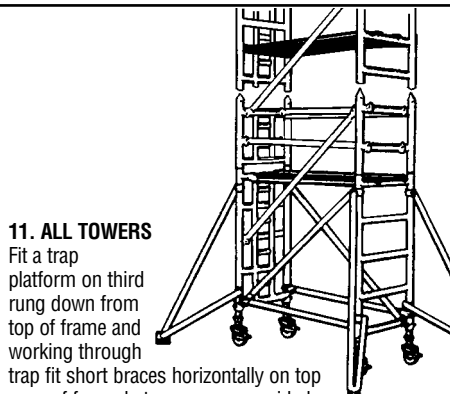

11. ALL TOWERS
Fit a trap platform on third rung down from top of frame and working through trap fit short braces horizontally on top rung of frame between pegs provided. Still using a platform & braces to aid safe erection, continue building the tower repeating the bracing pattern until the required platform height is reached.

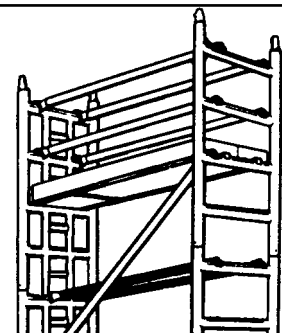

12. TOWERS FINISHING WITH 4 RUNG FRAMES.
Erect as shown up to (9), then:- Still using a platform & braces to aid safe erection fit platform on the third rung down in the same way as shown in (9). Working through the trap fit two short braces horizontally on to top rung of frames between pegs provided and two on first rung down over outside pegs.

LADDER SPAN ERECTION MANUAL WITH 4 RUNG STARTER FRAMES

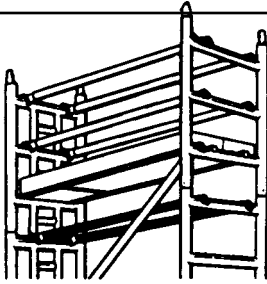

13. TOWERS FINISHING WITH 3 RUNG FRAMES

Still using a temporary platform & braces to aid safe erection erect tower as shown up to (11). Repeat (11) but use 3 rung frame and use either blue braces or black braces provided. Fit trap platform on the third rung down in the same way as shown in (9). Working through the trap fit two short braces horizontally onto top rung of frames between pegs provided and two on first rung down over outside pegs.

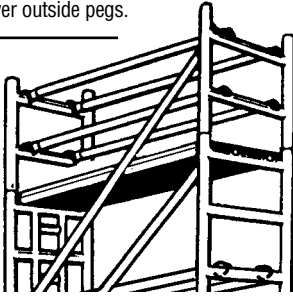

14. TOWERS FINISHING WITH GUARDRAIL FRAMES

Guardrail frames can be used at the top of the tower instead of 2 rung frames lower down, but they will need the intermediate platforms to be rearranged before forming the top platform. Using a temporary platform & braces to aid safe erection fit two G.R. frames (2 rung) by locating onto head fitting with peg engaging into hole provided. Fit two short braces horizontally onto top rungs of frames between pegs provided and two on first rung down over outside pegs. Fit one long brace diagonally from top rung of frame as close to the frame vertical tubes as possible. Relocate the top platform into its final position.

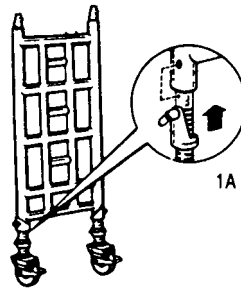

1. These towers should be erected by at least 2 competent persons. Apply brakes and fit adjustable castors into one 4 rung ladder frames and one 4 rung main frame, ensuring that spring loaded pin is engaged in hole provided (see detail 1A).

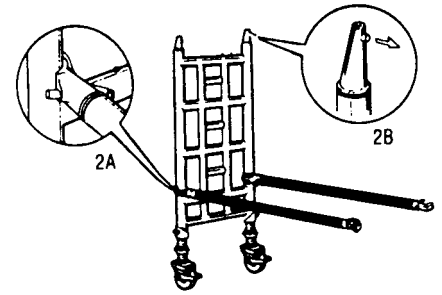

2. Make sure pegs on frame head fitting always point towards middle of tower (see detail 2B). Fit two short horizontal braces to vertical tubes of one of the frames ensuring spring loaded pin faces outwards (see detail 2A).

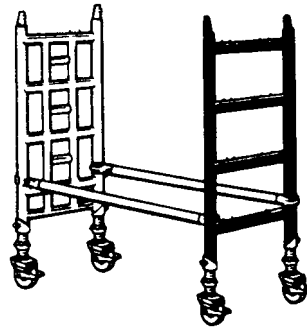

3. Fit opposite ends of short braces to other 4 rung frame ensuring pegs on frame head fitting point towards middle of tower.

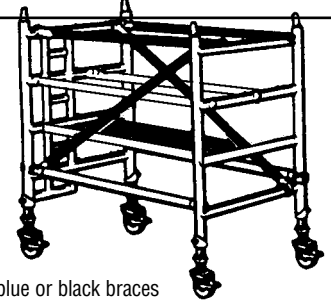

4.) Fit two blue or black braces (for a 1.8m tower fit blue and a 2.7m tower fit black) diagonally in opposite directions as close to the frame vertical tube as possible. 2) Fit a temporary platform on the third rung down from the top of the frame and working through the trap fit four short braces horizontally onto top rungs and second rungs of frames between pegs provided. At this stage level the tower by adjusting collar on castors (see construction notes). Continue as (5-14) on opposite page.

TYING IN

CONSTRUCTION NOTES

- Follow the erection manual to ensure that the correct erection procedure is used.
- Ensure that sufficient equipment is available to construct the tower and is in working order.
- Do not extend castor jacks more than is necessary to level the tower. Adjustable swivel base jacks are available for use on stepped, steeply sloped or soft ground conditions.
- Use a Spirit level to check that the tower is upright.
- The peg on the head fitting must always point inwards.
- Fit the first two horizontal braces to the vertical frame tube. This prevents the frame from falling over during erection and dismantling.
- All diagonal braces are fitted as close as possible to the upright.
- Observe all height limits (fig.5) and fit stabilisers to increase the safe working height to the tower. Towers may also be tied to a suitable rigid structure using standard scaffolding tubes and fittings (see tying in).
- Fit toeboards to all working platforms and ensure that all platforms are adequately guarded.
- The dismantling sequence is the reverse order of the erection process.
- For special or unusual applications contact your supplier for further technical data sheets and expert advice.
- During erection and dismantling any temporary platform used for building the tower, should be treated as a working platform with guard rails at 0.5m and 1.0m above platform.

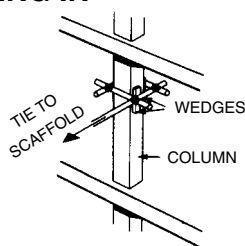

fig. A
SECURED TO SCAFFOLD

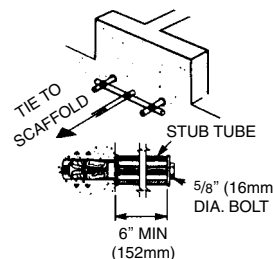

fig. B
SECURE TO EMBEDDED TIES IN CONCRETE

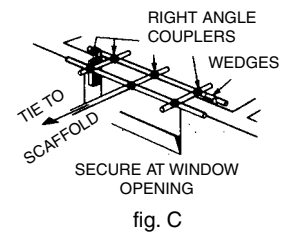

fig. C

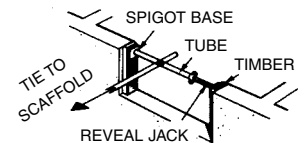

fig. D
SECURE TO REVEAL PROP

NOTE: Arrangement shown in fig. D is considered to be a friction device and should not exceed 1/2 the total number of scaffold ties in any area.

When friction devices are used the connection to the scaffold must be made onto both vertical uprights. Ties should be at no more than 4m intervals.

Beware of high winds: If high winds are forecast do not erect the tower or leave up overnight. When working on towers outdoors for long periods always listen to weather forecasts at night.

Wind-Description	Beaufort-Scale	Beaufort-No.	Speed in mph	Speed in m/sec	
Medium Breeze	Raises dust and loose paper small branches sway.	4	13 - 18	5.5 - 8	Safe to work on the tower.
Strong Breeze	Large branches in motion, telegraph wires whistle.	6	25 - 31	11 - 14	Tie the tower onto a solid Structure. Do not work on tower
Gale Force	Twigs snap off, walking is difficult.	8	39 - 46	17 - 21	Towers should on no account be erected in these conditions.

Beware of open ended building which can cause a funnelling effect.

ALL TOWERS

REST PLATFORMS

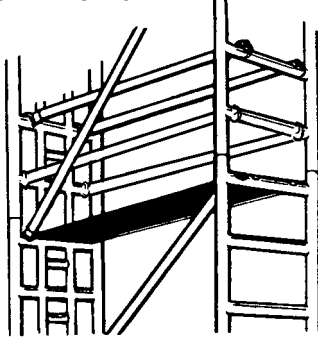

Rest platforms must be fitted every 2m and consist of a trap platform and guardrails at 0.5m and 1m as shown. Remember to always close trapdoor immediately after climbing through.

WARNING



WARNING: never work from or build, or dismantle the tower from an unguarded platform.

SAFETY NOTES

- Before erecting check ground is level unobstructed and is suitable for the purpose. Also ensure area is clear of overhead obstructions, particularly power cables.
- Check that brakes are applied and the tower is stable before use.
- Do not ride on the tower or attempt to move a loaded tower.
- Always climb the tower from the inside.
- Do not overload the tower. Maximum platform loads 200 kg/m² (2kN/m²). Maximum tower load 2500kg mobile. Maximum horizontal force at platform 30kg.
- When moving a tower, reduce the height to a maximum of 4m. Check that there are no power lines or other obstructions overhead.
- Mobile towers must be moved by pushing at the base only. Beware of soft or uneven ground, drains or potholes and overhead obstructions, especially power cables. Stabilisers may be raised to a maximum of 25mm above the ground. Immediately after moving, apply the brakes and check that the tower is upright and stable and stabilisers returned to ground level.
- Never remove components from a tower whilst it is erected. Dismantling must always be performed from the top. Failure to observe this rule will seriously reduce the strength and safety of the tower.
- Do not use damaged components. Check all components before use and periodically lubricate all moving parts and wipe off surplus oil.
- Beware of high winds. Secure the tower when in exposed positions and when left unattended.
- Do not lean ladders against towers or use ladders on top of platforms.
- At heights where components cannot be passed up or down by hand, a rope should be used for securing to components to aid safe raising and lowering.
- Never work from, or build or dismantle the tower from an unguarded platform.
- Legislation now calls for inspection and recording of assembled towers. See HSE guidance note 10 (revision 4) for further details.

SPAN TOWER WITH CLIP IN VERTICAL LADDERS ERECTION MANUAL

Span towers with clip in vertical ladders are built in exactly the same way as ladder span towers with 5 rung starter frames (page 2).

Where a ladder frame is shown on page 2, use a plain frame and then clip a 2m vertical ladder onto the horizontals on the inside of the frame, ensuring that the spring loaded pins on the ladder locate under the rung.

Note. You cannot use 3 rung frames with clip in vertical ladders. See also illustration 14.

COMPONENT SCHEDULE

SINGLE WIDTH SPAN TOWERS WITH CLIP-IN VERTICAL LADDERS TO EN 1004-3-8/12

Using the 3T (Through the Trap) Assembly method

INTERNAL & EXTERNAL USE

PLATFORM HEIGHT	METRIC	2.4	3.4	4.4	5.4	6.4	7.4
DESCRIPTION	IMPERIAL	7'10"	11'2"	14'5"	17'9"	21'0"	24'3"
1.8 m x 0.8 m SPAN	CODE						
150mm Adjustable Castors	2230	4	4	4	4	4	4
1.8m x 0.6m Toeboard	2065	1	1	1	1	1	1
Single Base Frame	2015	2	2	2	2	2	2
Single Main Frame	2016	-	2	2	4	4	6
Single G.R. Frame	2017	2	-	2	-	2	-
1.8m Brace	2040	6	10	10	14	14	18
2.69m Brace	2041	3	3	4	4	5	5
1.8m Trap Platform	2050	1	2	2	3	3	4
Small Stabiliser	2056	4	4	4	4	4	4
Large Stabiliser	2057	-	-	-	-	-	-
Vertical Ladder	2060	1	2	2	3	3	4
TOTAL SELF WEIGHT OF TOWER (KGS)		132	175	188	229	240	283
MAX. No. OF WORKING LEVELS		1	2	2	3	3	4

INTERNAL USE

8.4	9.4	10.4
27'7"	30'10"	34'1"
4	4	4
1	1	1
2	2	2
6	8	8
2	-	2
18	22	22
6	6	7
4	5	5
-	-	-
4	4	4
4	5	5
302	344	355
4	5	5

INTERNAL & EXTERNAL USE

PLATFORM HEIGHT	METRIC	2.4	3.4	4.4	5.4	6.4	7.4
DESCRIPTION	IMPERIAL	7'10"	11'2"	14'5"	17'9"	21'0"	24'3"
2.69 m x 0.8 m SPAN	CODE						
150mm Adjustable Castors	2230	4	4	4	4	4	4
2.6m x 0.6m Toeboard	2067	1	1	1	1	1	1
Single Base Frame	2015	2	2	2	2	2	2
Single Main Frame	2016	-	2	2	4	4	6
Single G.R. Frame	2017	2	-	2	-	2	-
2.69m Brace	2041	6	10	10	14	14	18
3.35m Brace	2042	3	3	4	4	5	5
2.69m Trap Platform	2051	1	2	2	3	3	4
Small Stabiliser	2056	4	4	4	4	4	4
Large Stabiliser	2057	-	-	-	-	-	-
Vertical Ladder	2060	1	2	2	3	3	4
TOTAL SELF WEIGHT OF TOWER (KGS)		149	202	214	265	277	330
MAX. No. OF WORKING LEVELS		1	2	2	3	3	4

INTERNAL USE

8.4	9.4	10.4
27'7"	30'10"	34'1"
4	4	4
1	1	1
2	2	2
6	8	8
2	-	2
18	22	22
6	6	7
4	5	5
-	-	-
4	4	4
4	5	5
349	401	413
4	5	5

Notes. The above schedule includes for:-

- 1 working level with span trap platform, toeboards and handrails at 1m and 0.5m.
 - A span trap platform and handrails at 0.5m and 1m as rest platform every 2m. To convert a rest platform to a working platform add a single toeboard.
- Maximum working load on a 0.61m wide x 1.8m long platform is 2kN/m² which is 212kgs.
- Maximum working load on a 0.61m wide x 2.7m long platform is 2kN/m² which is 324kgs.
- Maximum load on a tower (including the self weight of the tower) should not exceed 2500kgs.
- Maximum horizontal force when using hand tools, etc, should not exceed 30kgs.
- Stabilisers must be fitted.
- WGT KGS = Total self weight of tower.
- MAX PLATS = Maximum No. of working platforms.